

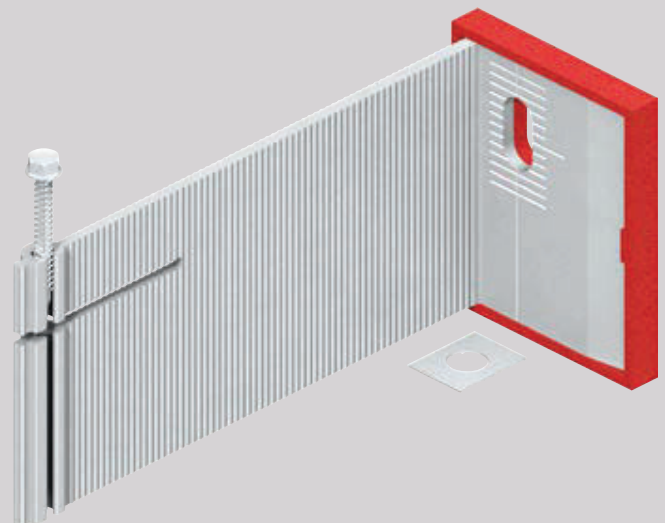

MFT-FOX-HI-1L- RIVETS-SCREWS

Hilti facade system



MFT-FOX-HI-1L-rivets-screws



View of cladding

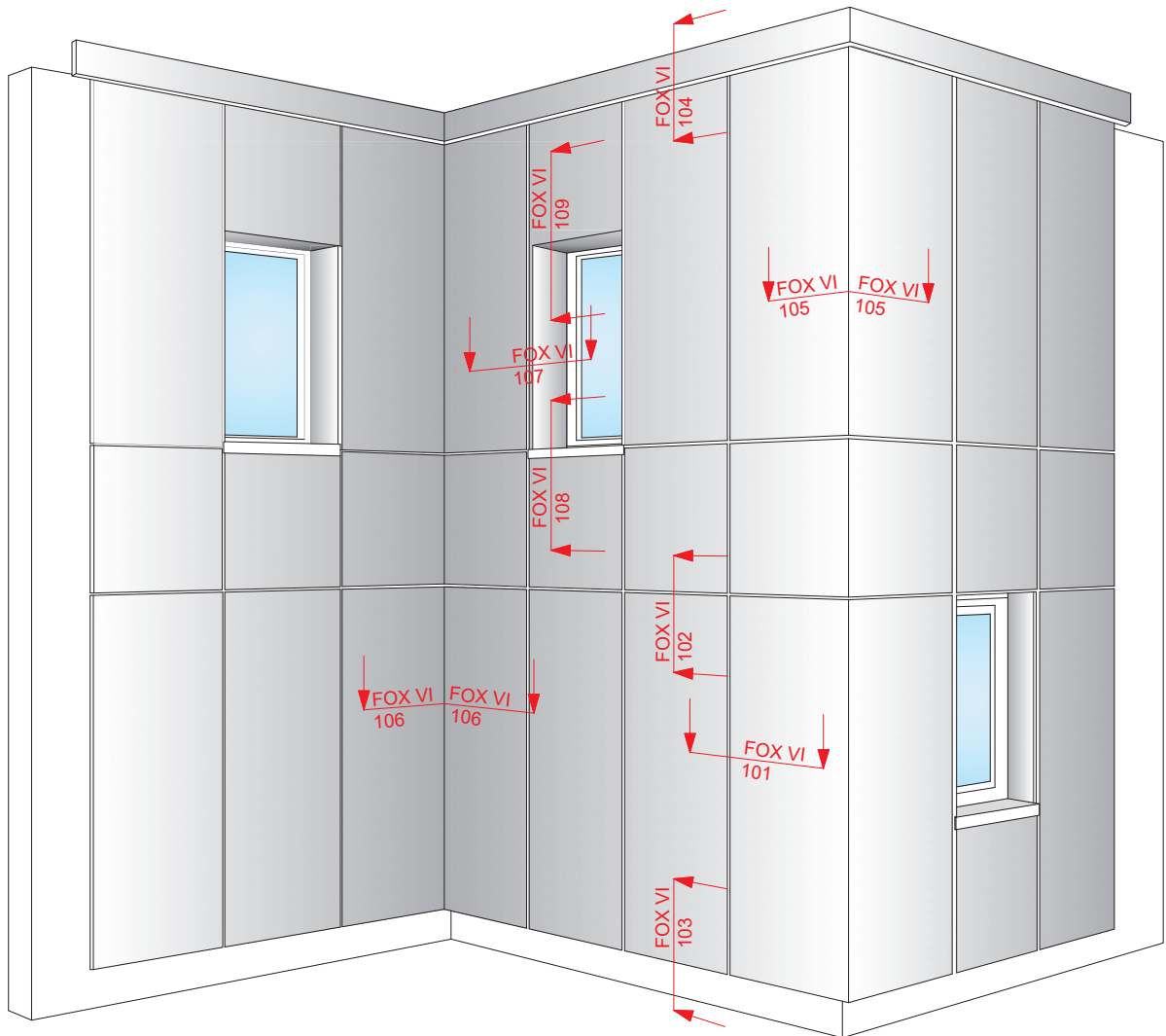

CONTENTS:

FOX VI	101	Horizontal section
FOX VI	102	Vertical section
FOX VI	103	Bottom detail
FOX VI	104	Top detail
FOX VI	105	Outside corner
FOX VI	106	Inside corner
FOX VI	107	Window - reveal
FOX VI	108	Window - sill
FOX VI	109	Window - lintel

MFT-FOX HI 101

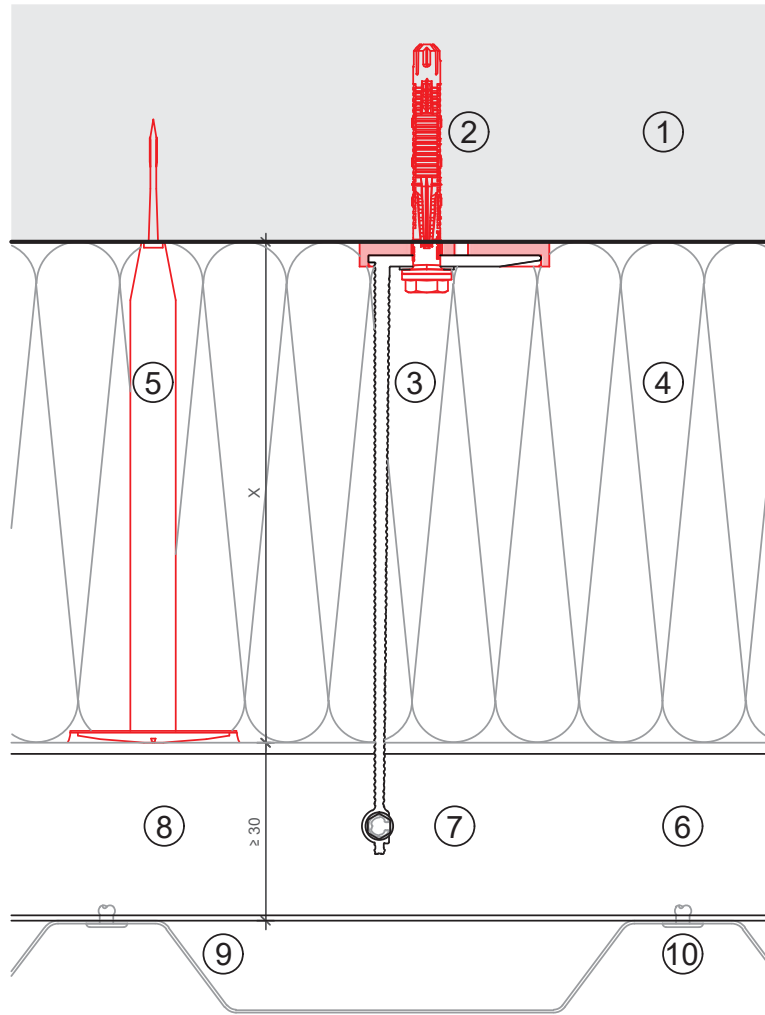

Legend:

- ① Base material
- ② Anchor acc. to static
- ③ Bracket and isolator
- ④ Insulation
- ⑤ Fixing insulation
- ⑥ Profile
- ⑦ Self drilling screw
- ⑧ Ventilation gap
- ⑨ Cladding
- ⑩ Fixing cladding

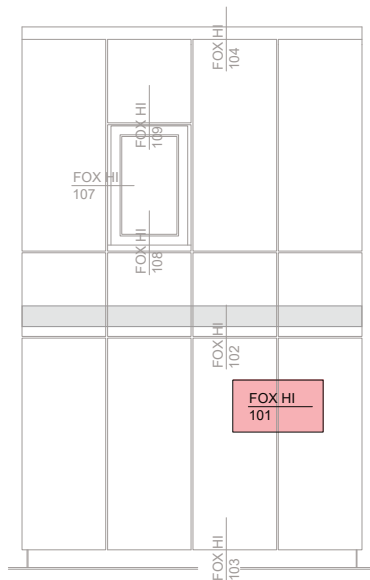

MFT-FOX HI 103

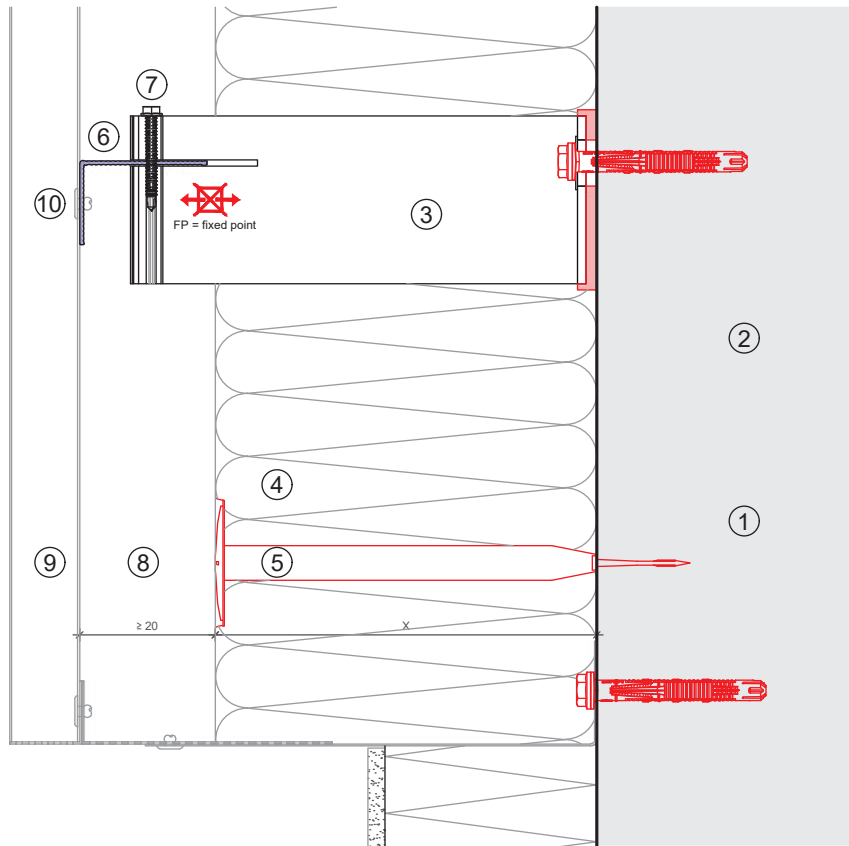

Legend:

- ① Base material
- ② Anchor acc. to static
- ③ Bracket and isolator
- ④ Insulation
- ⑤ Fixing insulation
- ⑥ Profile
- ⑦ Self drilling screw
- ⑧ Ventilation gap
- ⑨ Cladding
- ⑩ Fixing cladding

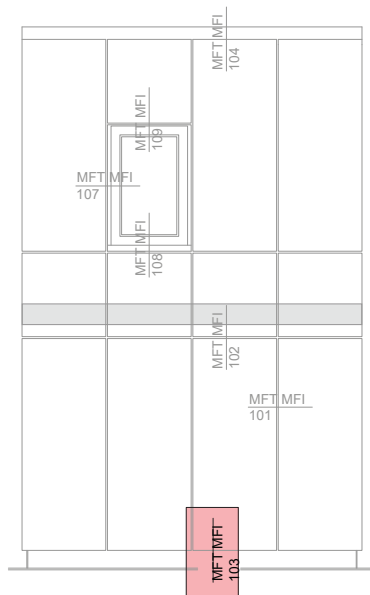

MFT-FOX HI 104

Legend:

- ① Base material
- ② Anchor acc. to static
- ③ Bracket and isolator
- ④ Insulation
- ⑤ Fixing insulation
- ⑥ Profile
- ⑦ Self drilling screw
- ⑧ Ventilation gap
- ⑨ Cladding
- ⑩ Fixing cladding

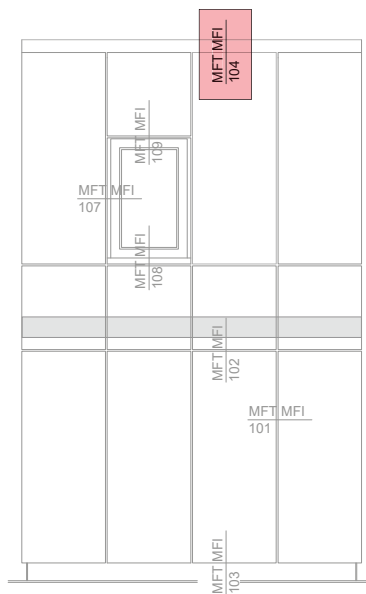
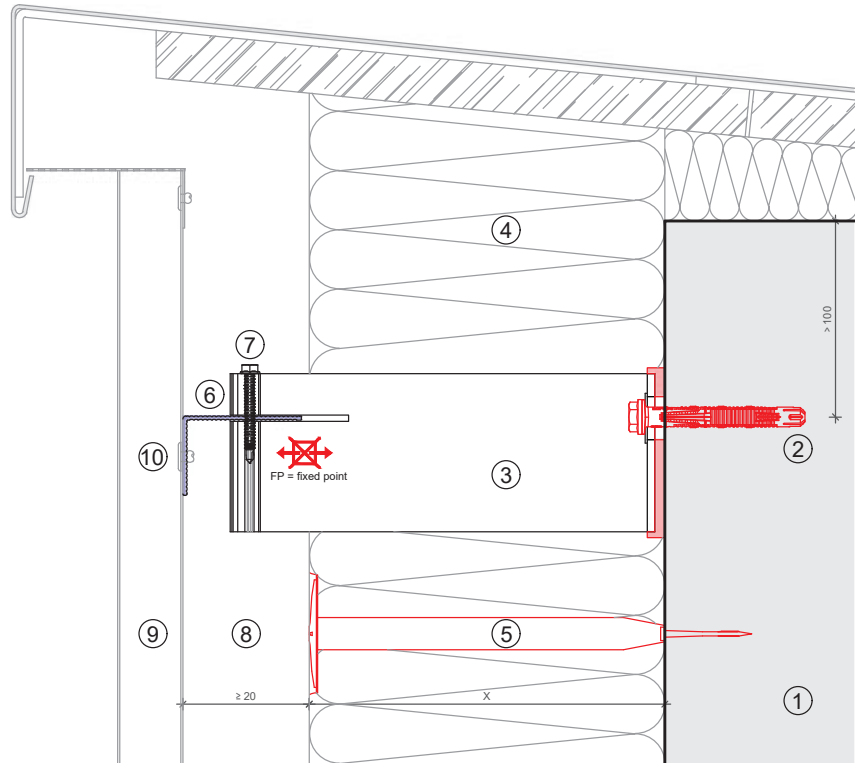

MFT-FOX HI 105

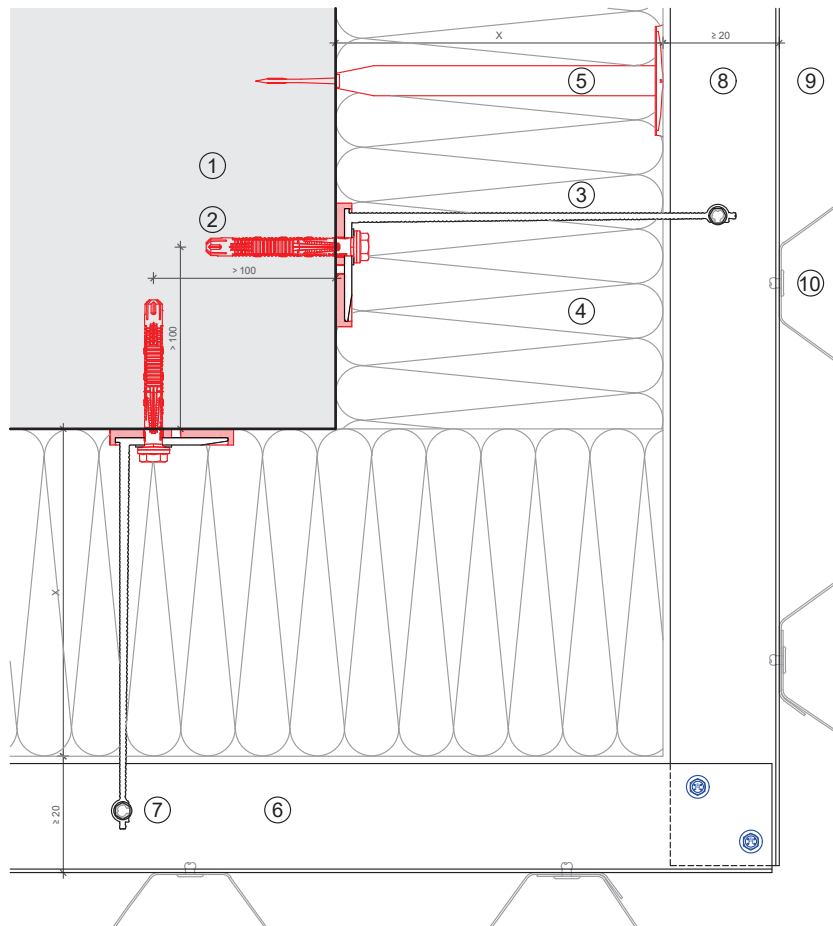

Legend:

- ① Base material
- ② Anchor acc. to static
- ③ Bracket and isolator
- ④ Insulation
- ⑤ Fixing insulation
- ⑥ Profile
- ⑦ Self drilling screw
- ⑧ Ventilation gap
- ⑨ Cladding
- ⑩ Fixing cladding

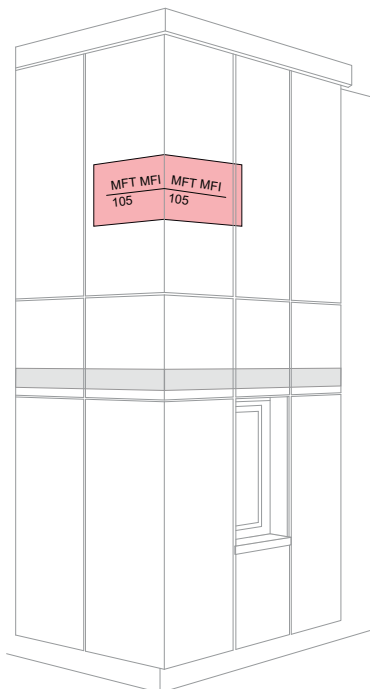

MFT-FOX HI 106

Legend:

- ① Base material
- ② Anchor acc. to static
- ③ Bracket and isolator
- ④ Insulation
- ⑤ Fixing insulation
- ⑥ Profile
- ⑦ Self drilling screw
- ⑧ Ventilation gap
- ⑨ Cladding
- ⑩ Fixing cladding

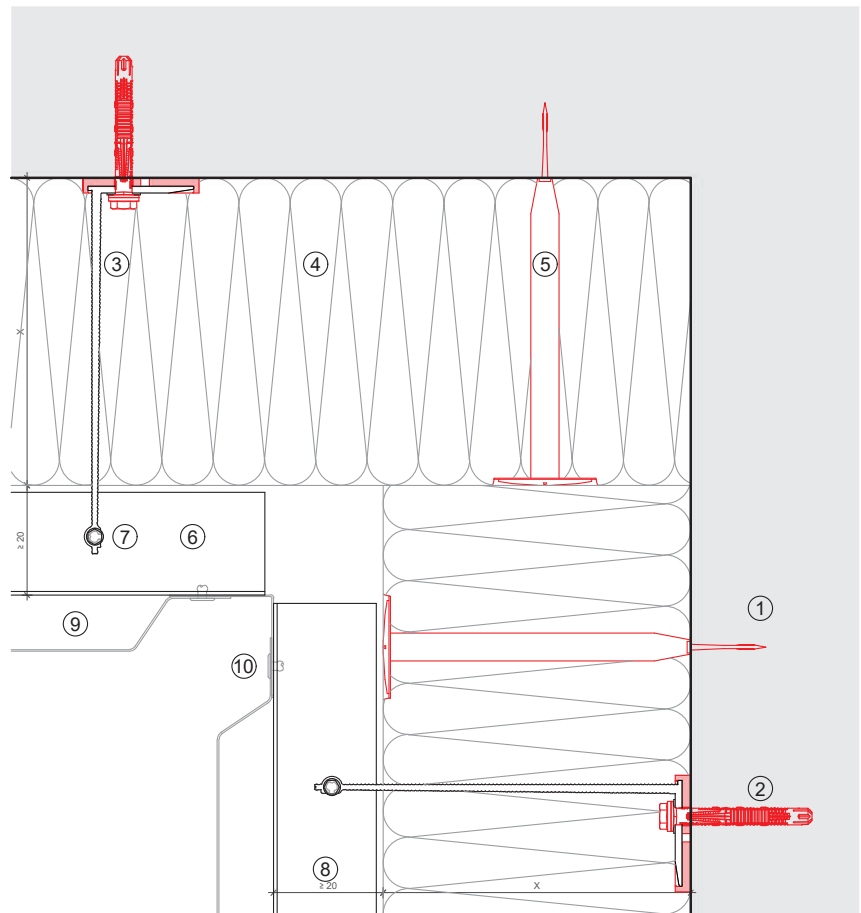

MFT-FOX HI 107

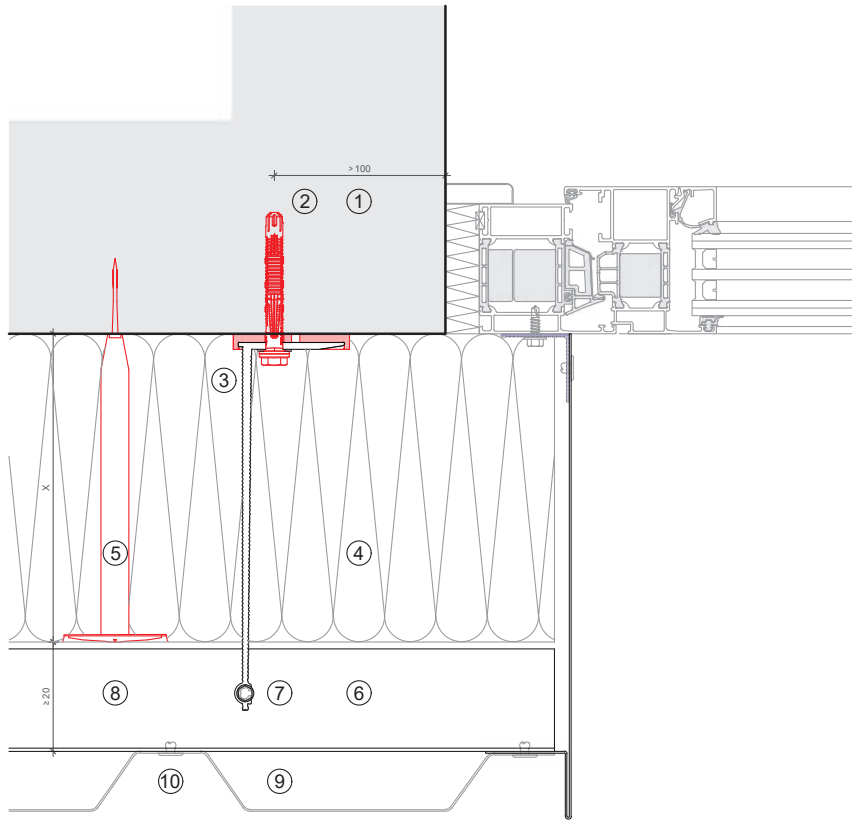

Legend:

- ① Base material
- ② Anchor acc. to static
- ③ Bracket and isolator
- ④ Insulation
- ⑤ Fixing insulation
- ⑥ Profile
- ⑦ Self drilling screw
- ⑧ Ventilation gap
- ⑨ Cladding
- ⑩ Fixing cladding

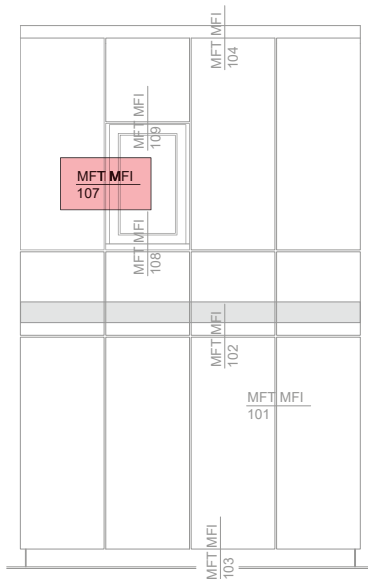

MFT-FOX HI 107

Legend:

- ① Base material
- ② Anchor acc. to static
- ③ Bracket and isolator
- ④ Insulation
- ⑤ Fixing insulation
- ⑥ Profile
- ⑦ Self drilling screw
- ⑧ Ventilation gap
- ⑨ Cladding
- ⑩ Fixing cladding

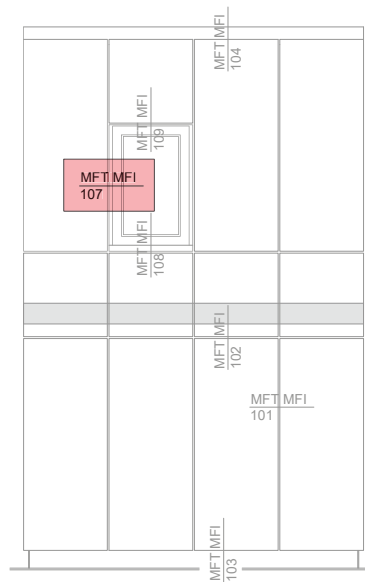
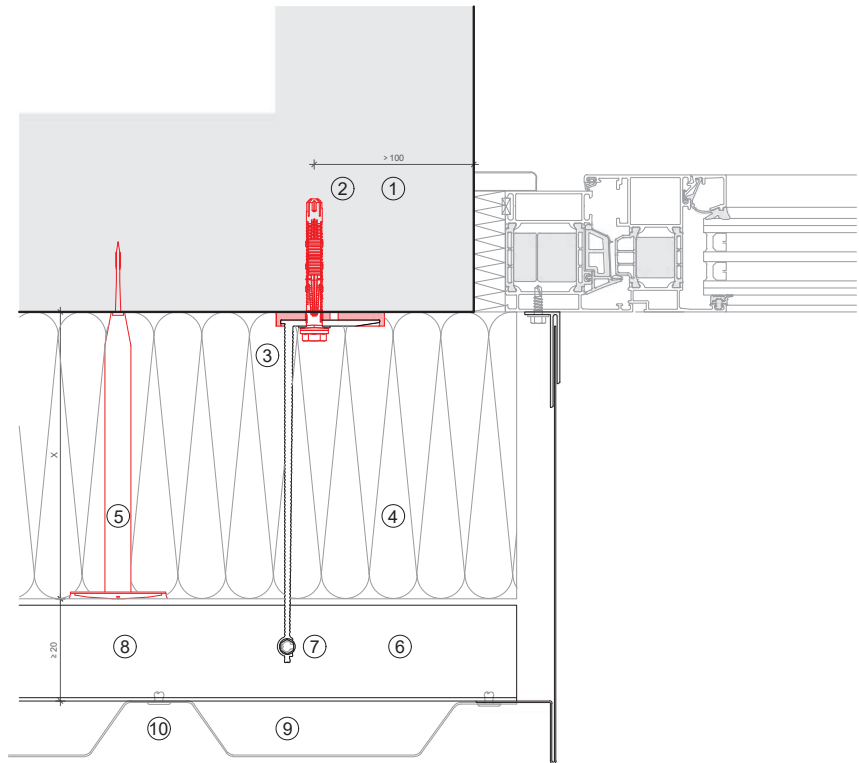

MFT-FOX HI 108

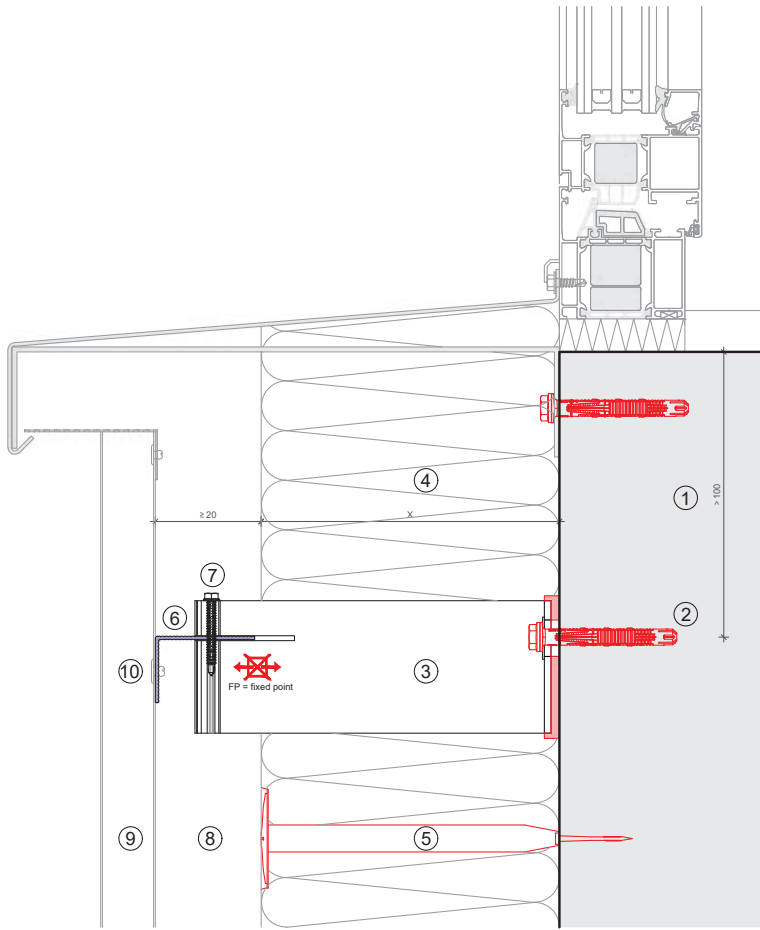

Legend:

- ① Base material
- ② Anchor acc. to static
- ③ Bracket and isolator
- ④ Insulation
- ⑤ Fixing insulation
- ⑥ Profile
- ⑦ Self drilling screw
- ⑧ Ventilation gap
- ⑨ Cladding
- ⑩ Fixing cladding

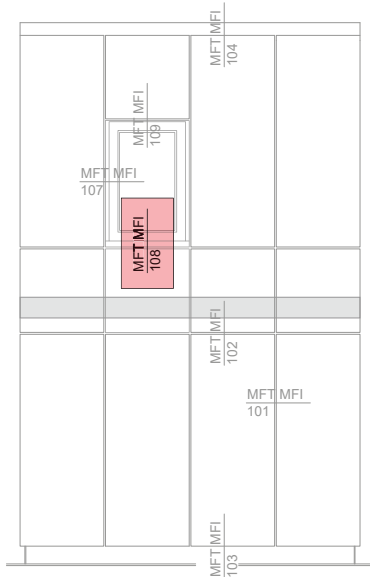

MFT-FOX HI 109

Legend:

- ① Base material
- ② Anchor acc. to static
- ③ Bracket and isolator
- ④ Insulation
- ⑤ Fixing insulation
- ⑥ Profile
- ⑦ Self drilling screw
- ⑧ Ventilation gap
- ⑨ Cladding
- ⑩ Fixing cladding

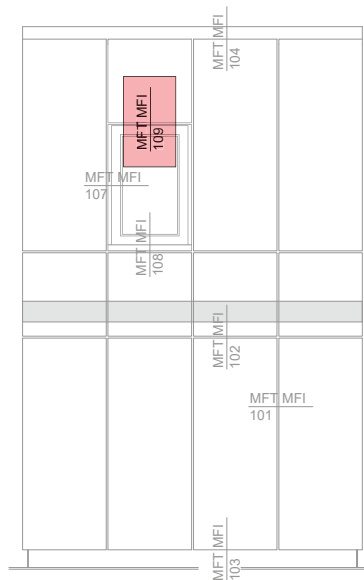
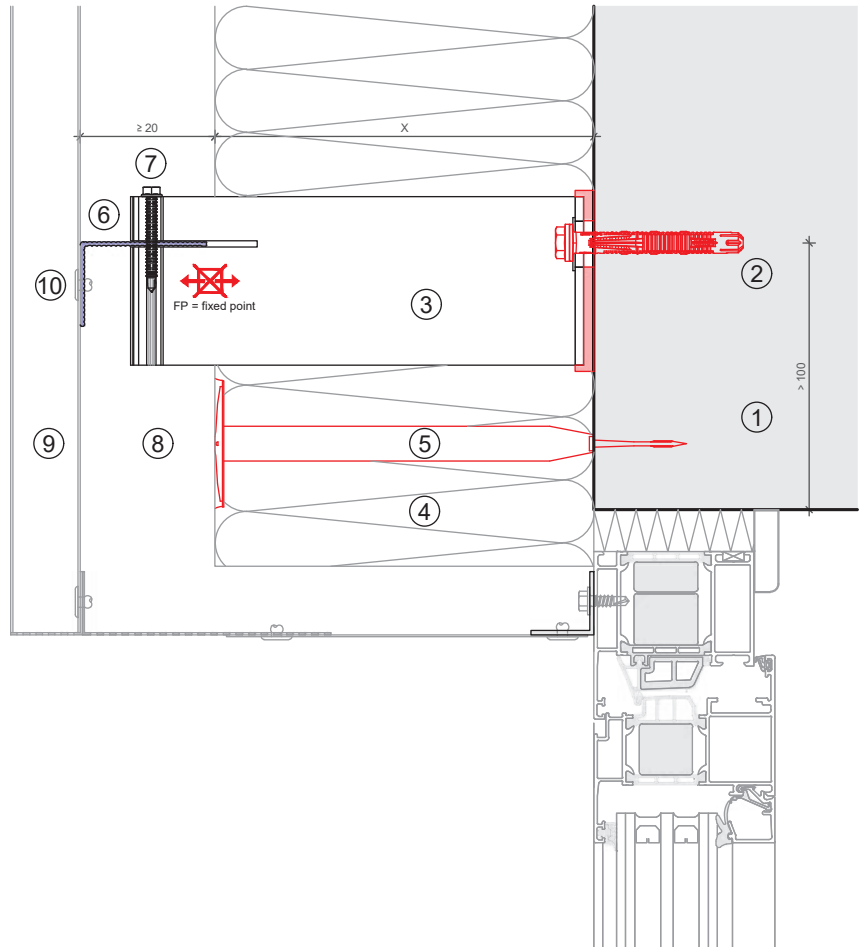

MFT-FOX HI 109

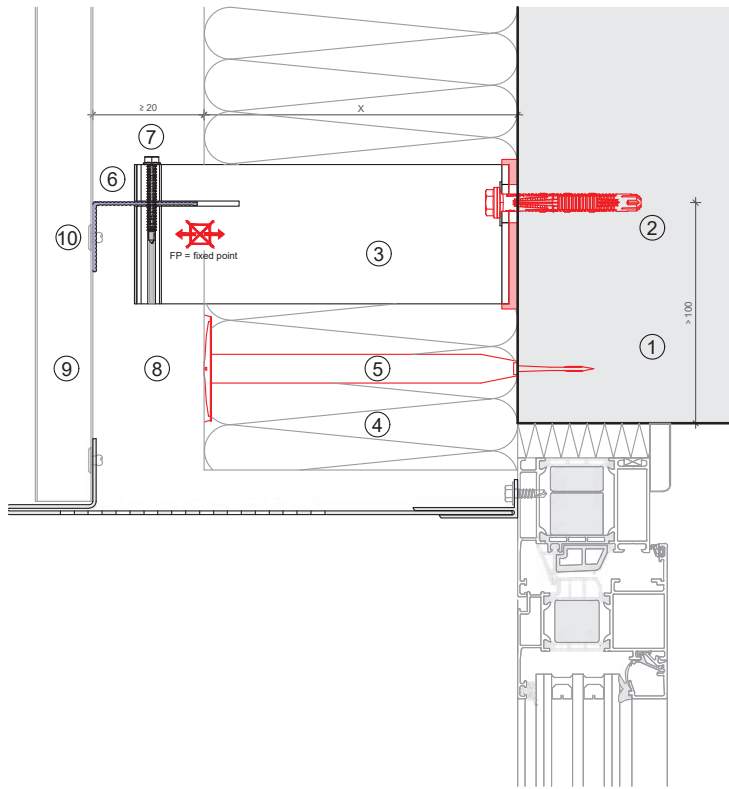

Legend:

- ① Base material
- ② Anchor acc. to static
- ③ Bracket and isolator
- ④ Insulation
- ⑤ Fixing insulation
- ⑥ Profile
- ⑦ Self drilling screw
- ⑧ Ventilation gap
- ⑨ Cladding
- ⑩ Fixing cladding

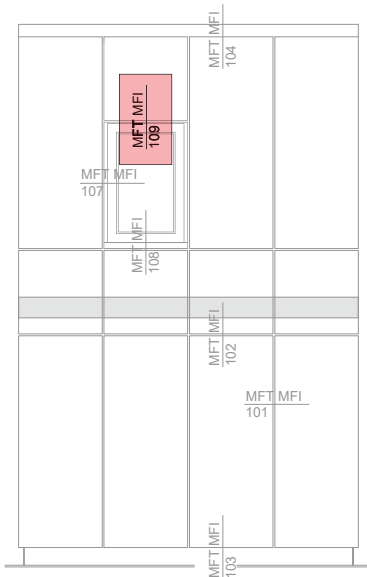

MFT-FOX HI 109

Legend:

- ① Base material
- ② Anchor acc. to static
- ③ Bracket and isolator
- ④ Insulation
- ⑤ Fixing insulation
- ⑥ Profile
- ⑦ Self drilling screw
- ⑧ Ventilation gap
- ⑨ Cladding
- ⑩ Fixing cladding

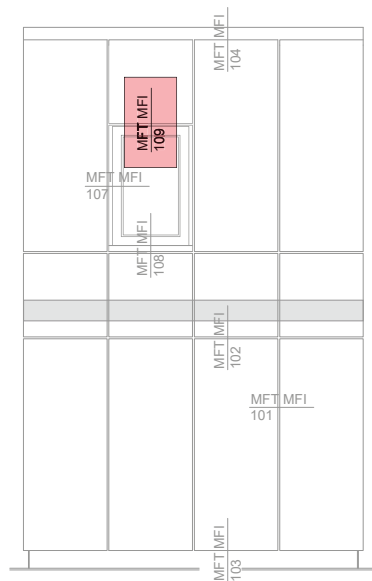
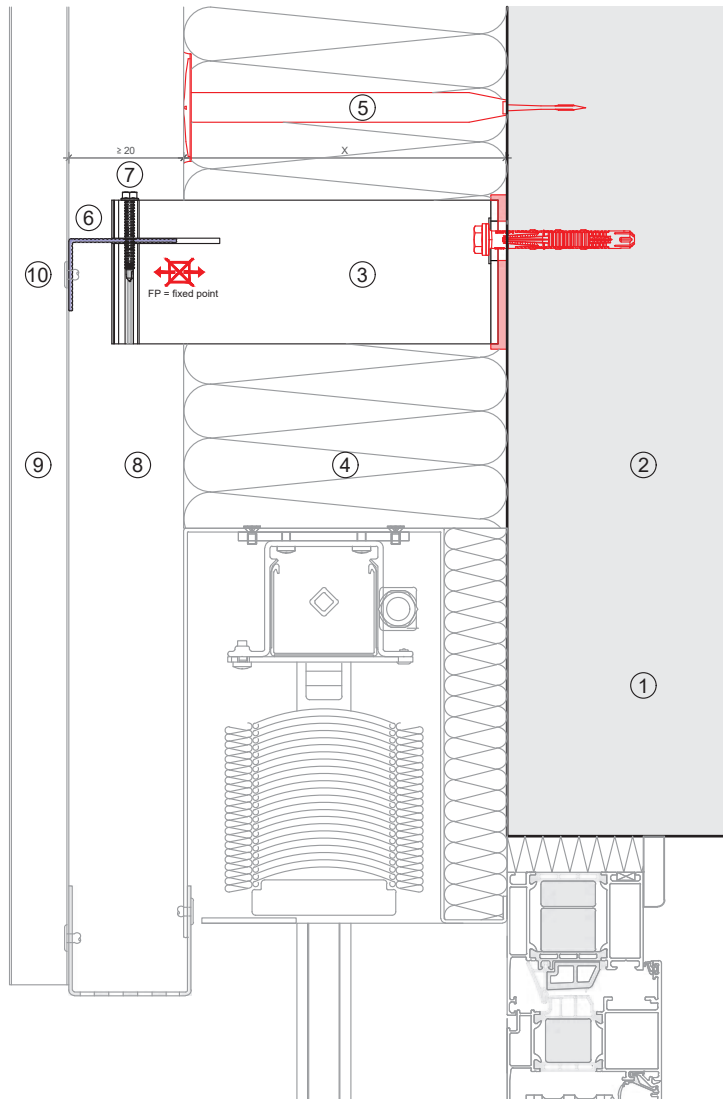

The data contained herein was current as of the date of publication. Updates and changes may be made based on later testing. If verification is needed that the data is still current, please contact the Hilti Technical Support Specialists at 1-877-749-6337. All published load values herein represent the results of testing by Hilti or test organizations. Because of variations in materials, on-site testing may be necessary to determine performance at any specific site.



Hilti, Inc.
1-800-879-8000 | en español 1-800-879-5000
www.hilti.com

Hilti (Canada) Corporation
1-800-363-4458
www.hilti.ca